

TOP VIEW

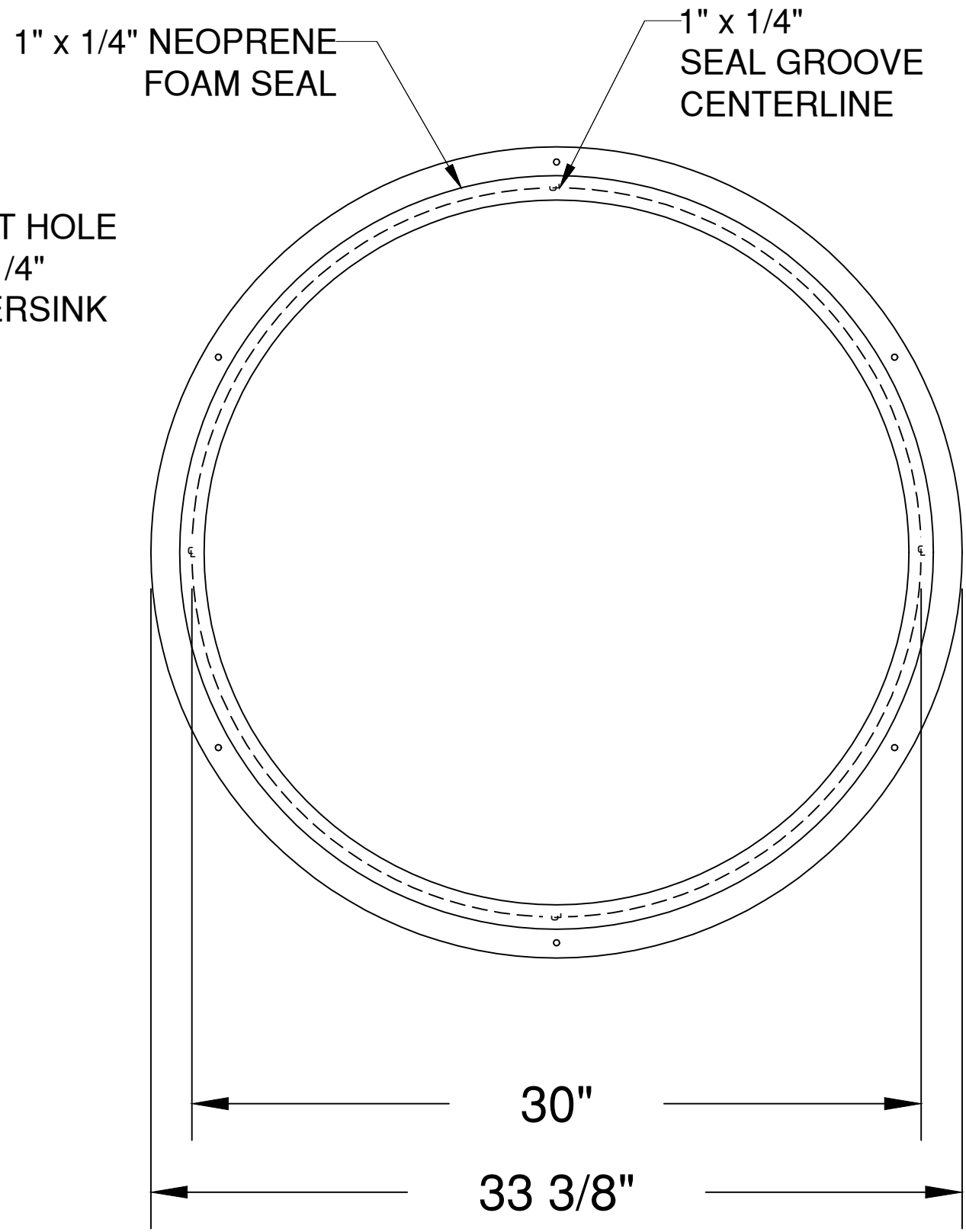

BOTTOM VIEW

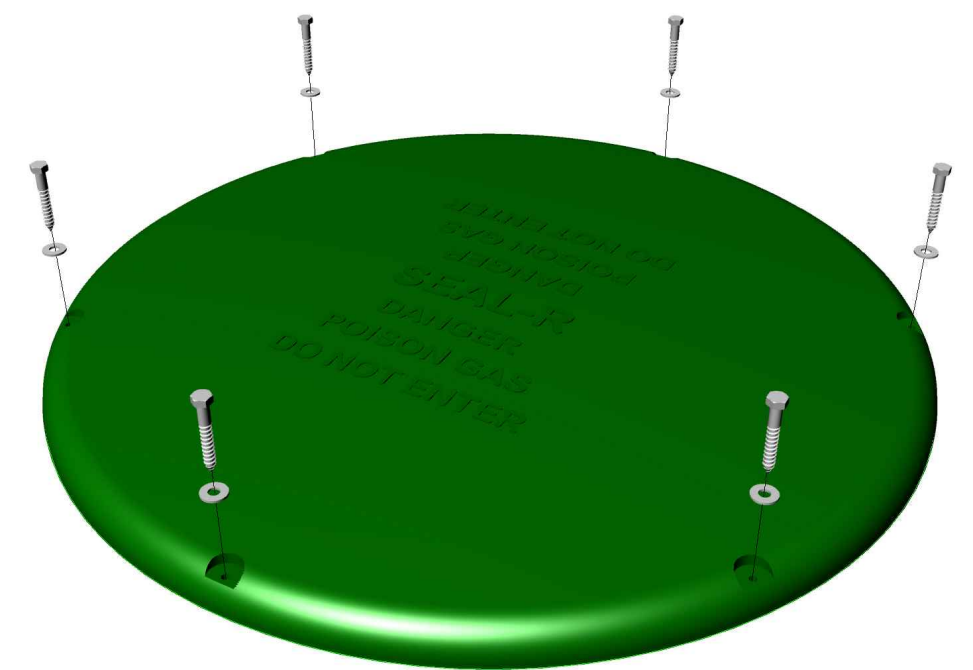

TOP PERSPECTIVE VIEW

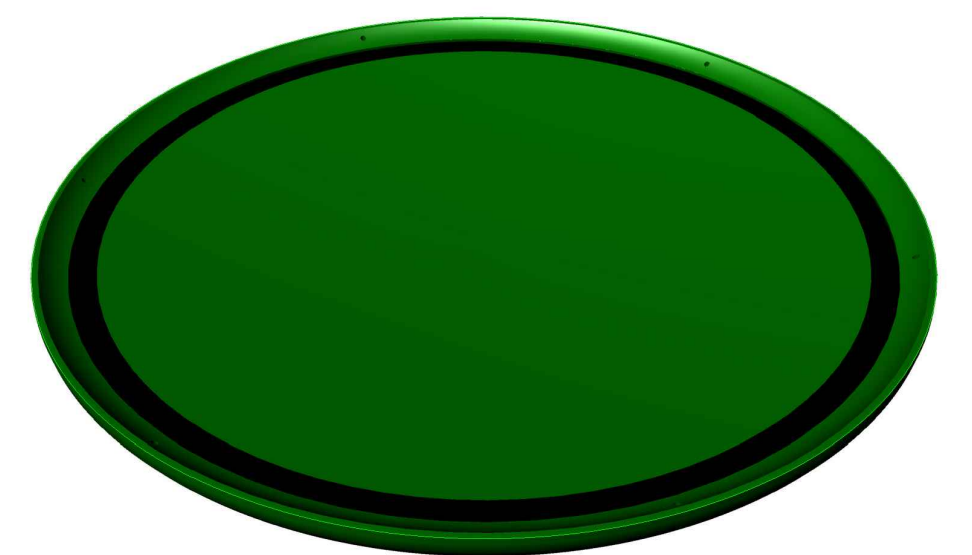

BOTTOM PERSPECTIVE VIEW

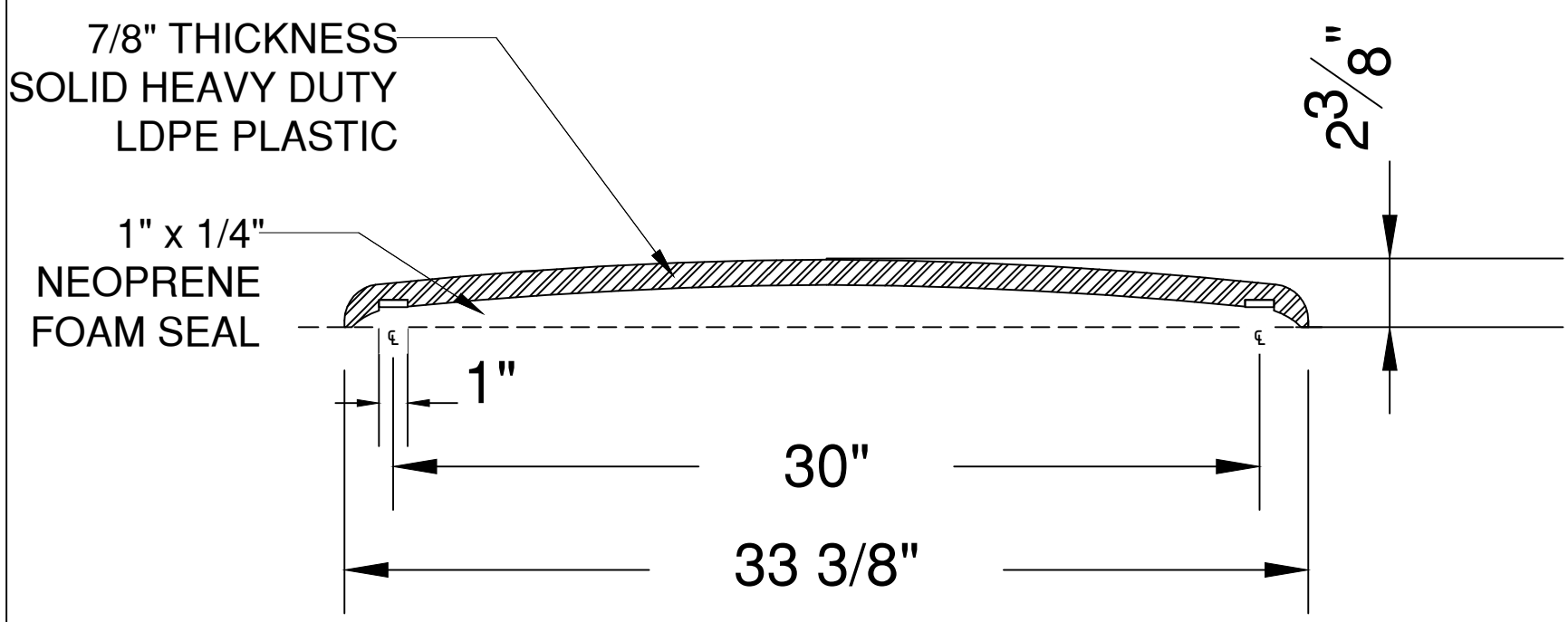

SECTION A-A

APPROXIMATE WEIGHT: 29 LBS

*ALL DIMENSIONS MAY HAVE SLIGHT VARIANCES



BrenLin
COMPANY, INC.

Manufacture of Seal-R™ Products

13999 Co Hwy 11
Herman, MN 56248
brenlin@frontiernet.net

DWG TITLE

**30 INCH RISER LID
OUTLINE DRAWING**

DWG NO.

SR30RL